



LAMDA

AWNINGS SYSTEMS MANUFACTURES

PROFESSIONALS

ΕΞΑΡΤΗΜΑΤΑ

COMPONENTS
ZUBEHÖR

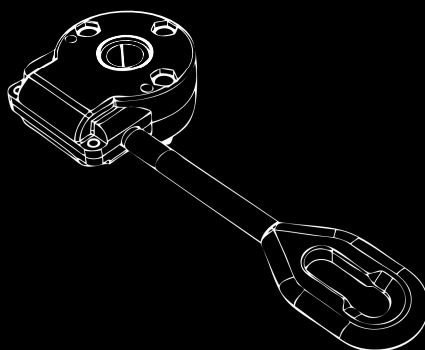

TÜV
AUSTRIA
HELLAS









EN ISO 9001: 2000

VISIT US









<http://pro.lamda.com.gr>



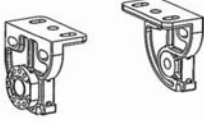



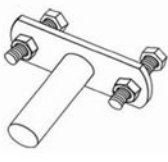

Μηχανισμοί
Reduction winch
Getriebe

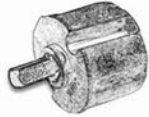
ΚΩΔ./CODE	ΕΙΚΟΝΑ/FIGURE	ΠΕΡΙΓΡΑΦΗ/DESCRIPTION	INFO
010-X		Μηχανισμός καρέ 1:11 (χαλύβδινος) Reduction winch 1:11 (Steel) Getriebe 1:11 (Stahl) Και για κάθετες τέντες Also for vertical awnings Auch für senkrechte Markisen	
010-Z	 	Μηχανισμός 1:11 (Ζάμακ) Reduction winch 1:11 (Zamak) Getriebe 1:11 (Zamak) Για τέντες με 2 βραχίονες For awnings with 2 arms Für Markisen mit 2 Gelenkarme	
0108-Z		Μηχανισμός 1:11 (Μακρύ) Reduction winch 1:11 (Long hand) Getriebe 1:11 (Lang)	
0101-K		Μηχανισμός καρέ 1:16 (4 Ρουλεμάν) Reduction winch 1:16 (4 bearings) Getriebe 1:16 (4 kugellager)	4R
0102-N		Μηχανισμός μαρκίζας 1:17 special (Οροφής) Reduction winch 1:17 Special (Ceiling) Getriebe 1:17 special (Decke)	2RZZ
0101-N		Μηχανισμός λαμάκι Special 1:17 Reduction winch 1:17 Special Getriebe 1:17 Special	2RZZ
0102		Μηχανισμός μαρκίζας 1:17 (Οροφής) Reduction winch 1:17 (Ceiling) Getriebe 1:17 (Decken)	
0101		Μηχανισμός λαμάκι 1:17 Reduction winch 1:17 Getriebe 1:17	

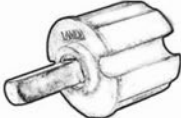

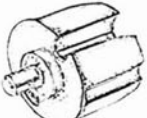



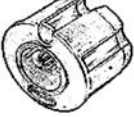

Κουζινέτα
Wall Ceiling brackets
Wandlager

ΚΩΔ./CODE	ΕΙΚΟΝΑ/FIGURE	ΠΕΡΙΓΡΑΦΗ/DESCRIPTION	INFO
0139-85		Λαμάκι μηχανισμού αλουμ. μεγάλο Wall ceiling bracket alum. large Wandlager Alum. Groß	Φ85
0139		Λαμάκι μηχανισμού - μοτέρ Wall ceiling bracket Wandlager	
0139-9		Λαμάκια μεταβλητού μήκους Brackets variable length Konsolen - Veränderlinch länge	
0038-AL		Λαμάκια κονσόλας αλουμινίου (με φορετό άξονα) Brackets set aluminum Aluminium abdeckung konsole	
0136		Κουζινέτο Φ14 Wall ceiling bracket Φ14 Wandlager Φ14	
0036		Κουζινέτο Φ14 (μεσαίο) Wall ceiling bracket Φ14 (intermediate) Wandlager Φ14 (mittleres)	
0037		Κουζινέτο σωληνωτό 1" (Φ33mm) Wall ceiling bracket 1"(Φ33mm) Wand lager Φ14 1"(Φ33mm)	
0038		Κουζινέτο σωληνωτό 1" (Φ33mm) μεσαίο Wall ceiling bracket 1"(Φ33mm) middle Wand lager Φ14 1"(Φ33mm) mittleres	
0119		Πειράκι κουζινέτου Φ14mm Plate with pin Φ14 mm Bolzen Φ14mm	

**Πλήμνες
Endcaps
Radnaben**

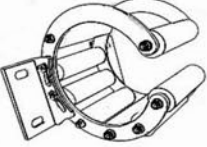
ΚΩΔ./CODE	ΕΙΚΟΝΑ/FIGURE	ΠΕΡΙΓΡΑΦΗ/DESCRIPTION	INFO
1251 1252 1253		Πλήμνη μηχανισμού Αλουμ.13X13X35mm Endcap Alum. 13X13X35mm Aluminium Radnabe 13X13X35mm	Φ60 Φ70 Φ78
1251-M 1252-M 1253-55		Πλήμνη μηχ/μού Αλουμ.13X13X67mm Endcap Aluminium 13X13X67mm Aluminium Radnabe 13X13X67mm	Φ60 Φ70 Φ78
0288 0289 0287		Πλήμνη μηχανισμού PVC 13X13X35mm Endcap PVC 13X13X35mm PVC Radnabe 13X13X35mm	Φ60 Φ70 Φ80
1252-P		Πλήμνη μηχανισμού PVC 13X13X67mm Endcap PVC 13X13X67mm PVC Radnabe 13X13X67mm	Φ70
0290 0291 0294		Πλήμνη κουζινέτου PVC με τρύπα 14mm Endcap PVC with hole 14mm PVC Radnabe mit 14mm Loch	Φ60 Φ70 Φ78
1255 1256 1257		Πλήμνη PVC Φ14mm Endcap PVC Φ14mm PVC Radnabe Φ14mm	Φ60 Φ70 Φ78
0291-O 0294-O		Πλήμνη κουζινέτου αλουμ. ρουλεμάν (+ πειράκι) Endcap aluminium with bearing (+ Pin) Aluminium Radnabe für lager mit kugellager	Φ70 Φ78
E 1241-M		Πλήμνη Φ60 X 25mm Endcap 60mm X 25mm Radnabe 60mm X 25mm	PVC
E 1241-K		Πλήμνη Φ60 X 1" PVC endcap 60mm X 33mm PVC Radnabe 60mm X 33mm	PVC
E 1243-M		Πλήμνη Φ70 X 25mm PVC endcap 70mm X 25mm PVC Radnabe 70mm X 25mm	PVC
E 1243-K		Πλήμνη Φ70 X 1" (70mm X 33mm) PVC endcap 70mm X 33mm PVC Radnabe 70mm X 33mm	PVC



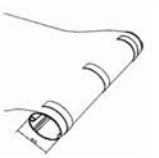







Χούφτες
Balance supports
Träger

ΚΩΔ./CODE	ΕΙΚΟΝΑ/FIGURE	ΠΕΡΙΓΡΑΦΗ/DESCRIPTION	INFO
0600		Χούφτα αλουμινίου οροφής / τοίχου Wall / ceiling tube support (aluminium) Wand / Decke Träger (Aluminium)	>3,0m Προβολή Projection
0604		Χούφτα μπάρας Balance support for bars (40 X 40mm) Rohrträger (40 X 40mm)	>3,0m Προβολή Projection
0606-40		Χούφτα μπάρας μεταλλική 40 X 40 mm Galvanized Balance support 40 X 40mm Verzinkt Rohrträger "Hercules" 40 X 40 mm	>4,0m Προβολή Projection
0601		Χούφτα μεταλλική (Γαλβανιζέ) Wall ceiling tube support (galvanized) Wand/Decke Träger (verzinkt)	>4,0m Προβολή Projection
0601-B		Χούφτα μεταλλική με ιμάντα (γαλβανιζέ) Balance support with belt (galvanized) Träger mit Riemen (verzinkt)	>4,0m Προβολή Projection
0602		Χούφτα μεγάλη Tube support large Großer Träger	>5,5m Προβολή Projection
0606		Χούφτα μπάρας "Hercules" 60 X 40 mm Balance support "Hercules" 60 X 40mm Rohrträger "Hercules" 60 X 40 mm	>5,0m Προβολή Projection
0606-D		Χούφτα μπάρας "Hercules Δίδυμα" Balance support for "Hercules twins" Rohrträger für "Hercules twins" 60 X 40 mm	>5,5m Προβολή Projection
0906		Κολλάρο τεντόπανου Φ50 & Φ60 Collar for fabric Φ50 & Φ60 Tuchkragen Φ50 & Φ60	
0907		Κολλάρο τεντόπανου Φ70 & Φ78 Collar for fabric Φ70 & Φ78 Tuchkragen Φ70 & Φ78	

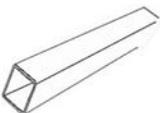
Σωλήνες - Μπάρες

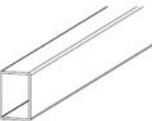
Tubes - Bars







Rohre- Balken

ΚΩΔ./CODE	ΕΙΚΟΝΑ/FIGURE	ΠΕΡΙΓΡΑΦΗ/DESCRIPTION	INFO
1966-BY		Τούμπο Φ60 X 1mm Wave roller tube Φ60 X 1mm Rohr Φ60 X 1mm	6,00m
1998-BY		Τούμπο Φ70 X 1,2mm Roller tube Φ70 X 1,2mm Rohr Φ70 X 1,2mm	5,00m 6,00m 7,00m
1995-BY		Τούμπο Φ78 X 1,5mm Roller tube Φ78 X 1,5mm Rohr Φ78 X 1,5mm	7,00m
0513-1 0513-2		Ένωση για τούμπο Roller tube joint Rohr Gelenk	Φ70 Φ78
0250		Μπάρα 40 X 40 X 2mm Λευκή γαλβανιζέ Square bar 40 X 40 X 2mm White galvanized Balken 40 X 40 X 2mm weiß Verzinkt	5,00m 6,00m
0513-M		Ένωση για μπάρα 40 X 40 mm Joint for 40 X 40mm bars Gelenk für Balken 40 X 40mm	35 X 35mm
0254		Κουλοδοκός 60 X 40 (γαλβανιζμένο / Λευκό) Bar 60 X 40 galvanized / white) Balken 60 X 40 (verzinkt / weiß)	6m
0541		Σωλήνα αλουμινίου 1" (33mm) Aluminium tube 1" (33mm) Aluminium Rohr 1" (33mm)	1,8m 2,0m 2,2m 6,0m
0544 0542		Σωλήνα λευκή μεταλλική (6m) Iron tube (white) (6m) Metallrohr (weiß) (6m)	1" 1 1/4"
0557 0557-7		Κολωνάκι αλουμινίου 0,6m Κολωνάκι αλουμινίου 0,7m Aluminium elbow 33mm 0,6m Aluminium Ellenbogen 33mm 0,7m	



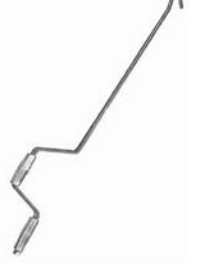

Μανιβέλες και Κόμπλερ

Cranks - Joints



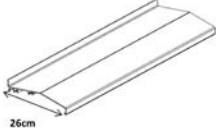

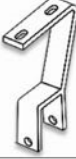

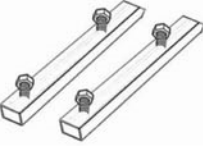
Kurbeln - Gelenke

ΚΩΔ./CODE	ΕΙΚΟΝΑ/FIGURE	ΠΕΡΙΓΡΑΦΗ/DESCRIPTION	INFO
0140-0 0140-1 0140 0141 0142 01433		Μανιβέλα σωληνωτή Φ14mm, (Γαλβανιζέ & Λευκή) Crank Φ14mm, (Galvanized & White) Röhrenartige Kurbel Φ14mm, (verzinkt & weiß)	1,00m 1,60m 1,75m 2,00m 2,20m 3,00m
0129 0124 0130 0131 0132		Μανιβέλα συμπαγής Φ9,5mm, (Γαλβανιζέ & Λευκή) Crank Φ9,5mm, (Galvanized & White) Kurbel Φ9,5mm, (verzinkt & weiß)	1,00m 1,60m 1,75m 2,00m 2,20m
0117 0116 0120 0121 0122 0123		Μανιβέλα συμπαγής Φ9,5mm, (Γαλβανιζέ) Crank Φ9,5mm, (Galvanized) Kurbel Φ9,5mm, (verzinkt)	1,00m 1,60m 1,75m 2,00m 2,20m 2,50m
0040		Κουζινέτο κομπλερ Φ60 Complex bracket Φ60 Komplexes Lager Φ60	
0041		Κουζινέτο κομπλερ Φ70 Complex bracket Φ70 Komplexes Lager Φ70	
0042		Κουζινέτο κομπλερ Φ78 Complex bracket Φ78 Komplexes Lager Φ78	

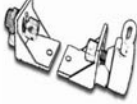
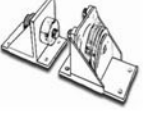

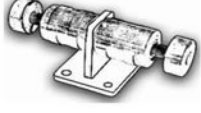





Στέγαστρο αλουμινίου
Aluminium hood
Aluminium Haube

ΚΩΔ./CODE	ΕΙΚΟΝΑ/FIGURE	ΠΕΡΙΓΡΑΦΗ/DESCRIPTION	INFO
0900	 A technical drawing of a U-shaped aluminium hood profile. A dimension line below the profile indicates a width of 26cm.	Στέγαστρο αλουμινίου 4mm (Σε ένα κομμάτι, όχι 2 προφίλ) Aluminium hood 4mm (one piece, not 2 profiles) Aluminium Haube 4mm (ein Stück, nicht 2 Profile)	4m 5m 6m 7m
0902	 A technical drawing of an L-shaped metal bracket with two screw holes on the horizontal part, used for mounting a hood to a wall.	Λαμάκι στεγαστρου Hood wall support Wandhalter für Haube	
0903	 A technical drawing of a Z-shaped metal bracket with two screw holes on the top horizontal part, designed for supporting a short bar.	Λαμάκι στεγαστρου μπάρας "κοντό" Hood wall support for bars "short" Wandhalter für Balken "kurz"	
0905	 A technical drawing of a Z-shaped metal bracket with two screw holes on the top horizontal part, designed for supporting a long bar.	Λαμάκι στεγαστρου μπάρας Hood wall support for bars Wandhalter für Balken	40 X 40 mm Casted
0901 0901-M	 A technical drawing showing two white, semi-circular PVC caps with a central hole, used to cover the ends of a hood.	Τάπες στεγαστρου PVC Hood PVC caps Kappen für Haube PVC	PVC METALLIC
BY-1100	 A technical drawing of a flexible, curved rubber trim strip with a small tab at one end, used to seal the hood cover.	Λάστιχο στεγαστρου Hood cover trim Gummi für Haube	
0900-E	 A technical drawing showing two aluminium profiles joined together using a metal bracket and four screws.	Ένωση στεγαστρου αλουμινίου Hood aluminium joint Gelenk für Aluminium Haube	





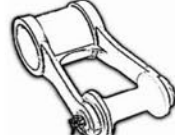



Εντατήρες - Γάντζοι
Roller tube stretcher - Hooks
Staffer set - Haken

ΚΩΔ./CODE	ΕΙΚΟΝΑ/FIGURE	ΠΕΡΙΓΡΑΦΗ/DESCRIPTION	INFO
0110		Εντατήρας Φ48mm Hand overdrive tube stretcher Φ48mm Staffer set Φ48mm	
0110-N		Εντατήρας Φ48mm Hand overdrive tube stretcher Φ48mm Staffer set Φ48mm	Νέου τύπου New type Neuartig
BY 117-7 BY 117-5		Σετ ηλεκτρικού εντατήρα Motor tube stretcher Motor staffer set	Φ70 Φ50
0111-7 0111-5		Σετ μεσαίου εντατήρα (για 2 μοτέρ) Motor tube stretcher (for 2 motors) Motor Staffer Set (for 2 Motoren)	Φ70 Φ50
0112-5		Μεσαία πλάκα ηλεκτρικού εντατήρα Middle complex bracket Komplexes Mittellager	Φ50
0112-7		Μεσαία πλάκα ηλεκτρικού εντατήρα Middle complex bracket Komplexes Mittellager	Φ70
0187		Γάντζος αλουμινίου Hook for deck (aluminium) Haken (Aluminium)	
0165-5		Γάντζος ράουλο 1" (αλουμινίου) Hook for pipe 1" (aluminium) Haken für Rohr 1" (Aluminium)	
0187-1		Γάντζος μονός 1" (αλουμινίου) Side hook 1" (aluminium) Seitenhaken 1" (Aluminium)	

Αντηρίδες
Greek awnings system
Griechisches Markisensystem

ΚΩΔ./CODE	ΕΙΚΟΝΑ/FIGURE	ΠΕΡΙΓΡΑΦΗ/DESCRIPTION	INFO
0156		Σπαστό χωρίς σπείρωμα (αλουμινίου) Elbow connection (aluminium) Ellenbogen Gelenk (Aluminium)	
0153		Σπαστό 1" X 1" (μεταλλικό) Elbow connection 1" X1" (metallic) Ellenbogen Gelenk (metallisch)	
0148		Φλάντζα χωρίς σπείρωμα (αλουμινίου) Tube bracket (aluminium) Rohrlager (Aluminium)	
0145 0146		Φλάντζα 1" (αλουμινίου) Φλάντζα 1" (μεταλλική) Tube joint 1" (aluminium) Tube joint 1" (metallic) Rohrgelenk (Aluminium) Rohrgelenk (metallisch)	
0144 0147		Φλάντζα 1"1/4" (αλουμινίου) Φλάντζα 1"1/4" (μεταλλική) Tube joint 1"1/4 (aluminium) Tube joint 1"1/4 (metallic) Rohrgelenk (aluminium) Rohrgelenk (metallisch)	
0145-T		Φλάτζα αλουμινίου 1" ("τυφλή") Tube bracket 1" (aluminium) Rohrlager (Aluminium)	
0161		Ράουλο αλουμινίου 1" Aluminium Return pulley 1" Aluminium Umlenkrolle	
0162		Ράουλο αλουμινίου 1"1/4 Aluminium Return pulley 1"1/4 Aluminium Umlenkrolle 1"1/4	
0160		"Π" αντηρίδος 1" (μεταλλικό) Ceiling bracket 1" (metallic) Deckenlager (metallisch)	
0173 0175 0176		Σύνδεσμος "T" (μεταλλικός) "T" connection (metallic) "T"Gelenk (metallisch)	1" X 1" 1" X 1 1/4" 1 1/4" X 1 1/4"

Πλαστικά εξαρτήματα
Plastic components
Kunststoffteile

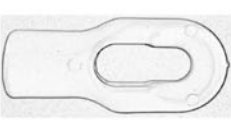
ΚΩΔ./CODE	ΕΙΚΟΝΑ/FIGURE	ΠΕΡΙΓΡΑΦΗ/DESCRIPTION	INFO
E 1241-A		Πλαστικό Φ60 X 25mm PVC endcap 60mm X 25mm PVC Radnabe 60mm X 25mm	
E 1241-B		Πλαστικό Φ60 X 1" (60 X 33mm) PVC endcap 60mm X 33mm PVC Radnabe 60mm X 33mm	
E 1243-A		Πλαστικό Φ70 X 25mm PVC endcap 70mm X 25mm PVC Radnabe 70mm X 25mm	
E 1243-B		Πλαστικό Φ70 X 1" (70mm X 33mm) PVC endcap 70mm X 33mm PVC Radnabe 70mm X 33mm	
E 1244		Τάπα βίδας 1" Plastic cap 1" Kunststoffdeckel 1"	
E 1244-B		Τάπα με σύρμα 1" Plastic cover 1" Kunststoffdeckel 1"	
E 1246 E 1247 E 1248		Τάπα για βίδα Plastic cover for bolt Kunststoffdeckel	13mm 17mm 19mm
E 1212		Ούπατ S 12mm Upat 12mm Bolzenanker	
BY186		Καρούλι Reel Rolle	
BY187		Θηλιά μηχανισμού PVC PVC noose for reduction winch PVC Schlinge für Getriebe	

Αντιρρίδες με αυτόματο κλείδωμα
Balkony awning auto lock
Selbstverriegelnde Balkonmarkisen

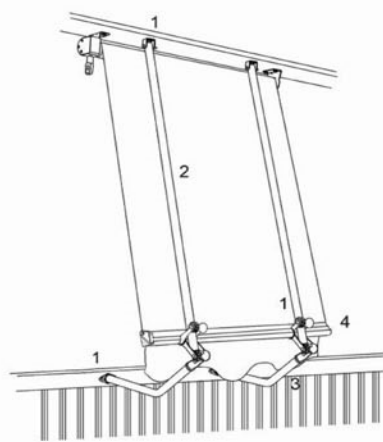

4,00m

Maximum dimensions

2,50m

Wind class 3

ΚΩΔ./CODE	ΕΙΚΟΝΑ/FIGURE	ΠΕΡΙΓΡΑΦΗ/DESCRIPTION	INFO	M.M./U.M.
0156-9		Σετ αυτόματης αντιρρίδας Balkony accessories auto lock Selbstverriegelnde Balkonmarkise Zubehör		Set
0541		Σωλήνα αλουμινίου 1" Aluminium tube 1" (Φ33mm) Aluminium Rohr 1" (Φ33mm)		Μέτρο Meter Messen
0557		Κολωνάκι αλουμινίου Aluminium "elbow" Aluminium Gelenkbogen	0,60m	Τεμ. Piece Stück
0520		Αντίβαρο τετράγωνο Square front bar Viereckige Fallstange	6,00m	Μέτρο Meter Messen